



ICFO^R

**Institut
de Ciències
Fotòniques**

March 2012 - ICFO

**M. Mičuda,
A. Vallés, M. Hendrych, J. P. Torres**



INVESTMENTS IN EDUCATION DEVELOPMENT

Bragg reflection waveguide - BRW

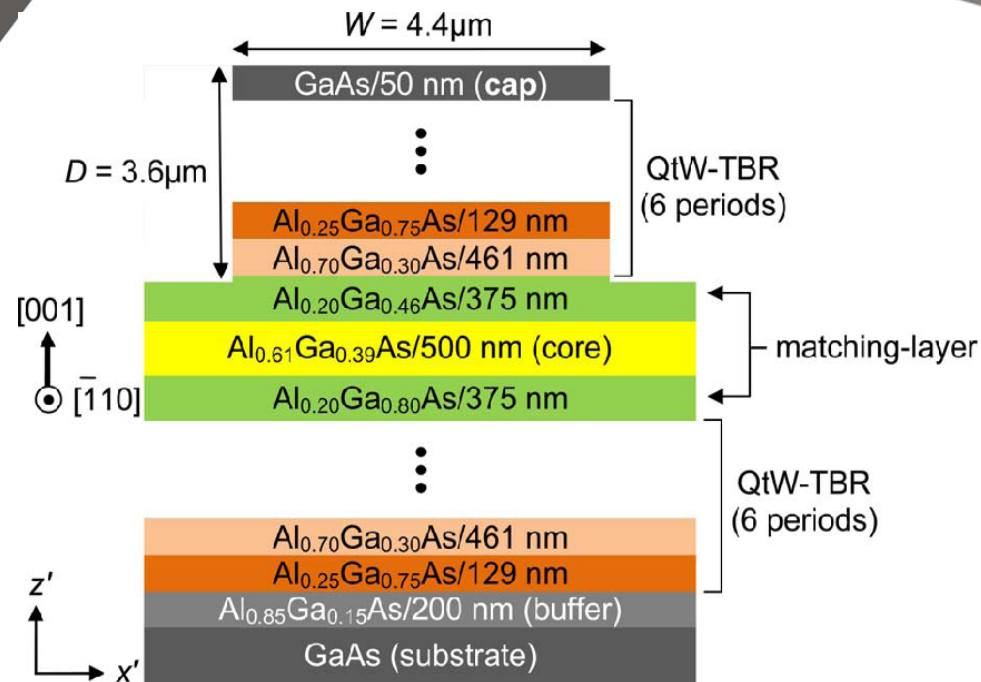
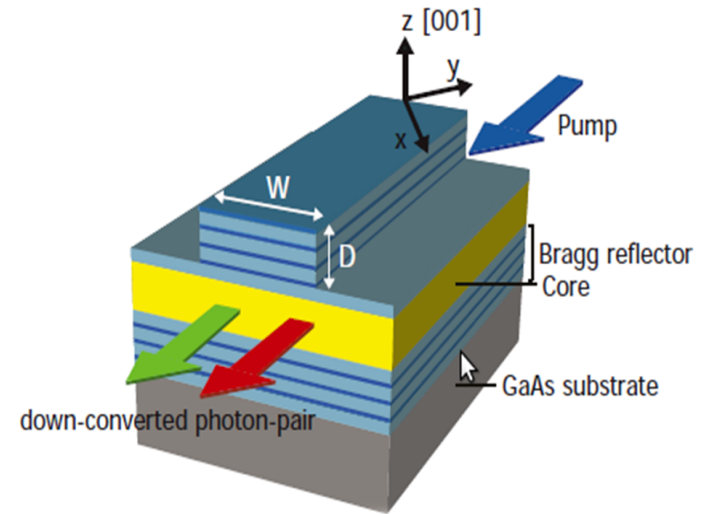
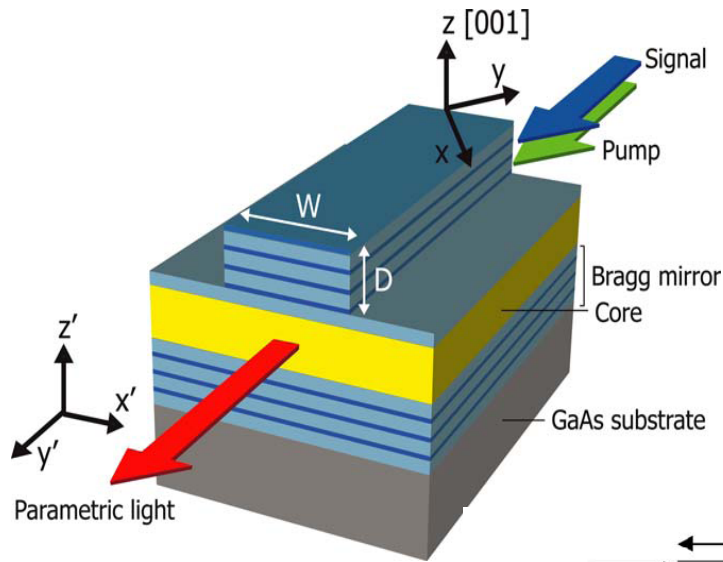

Setup

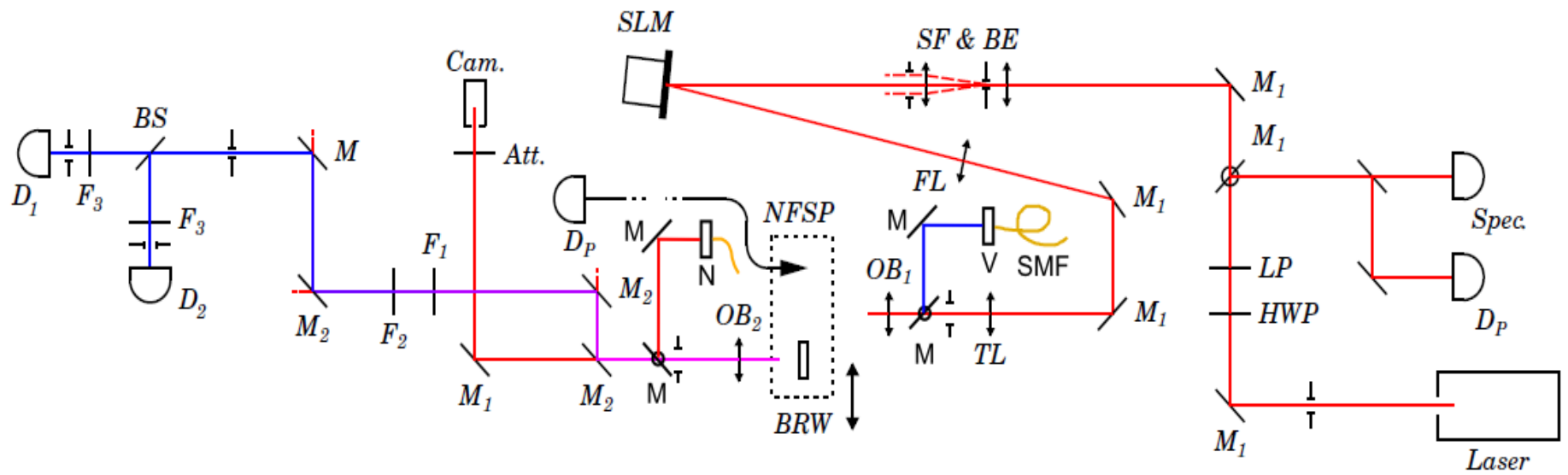

Setup – part 1

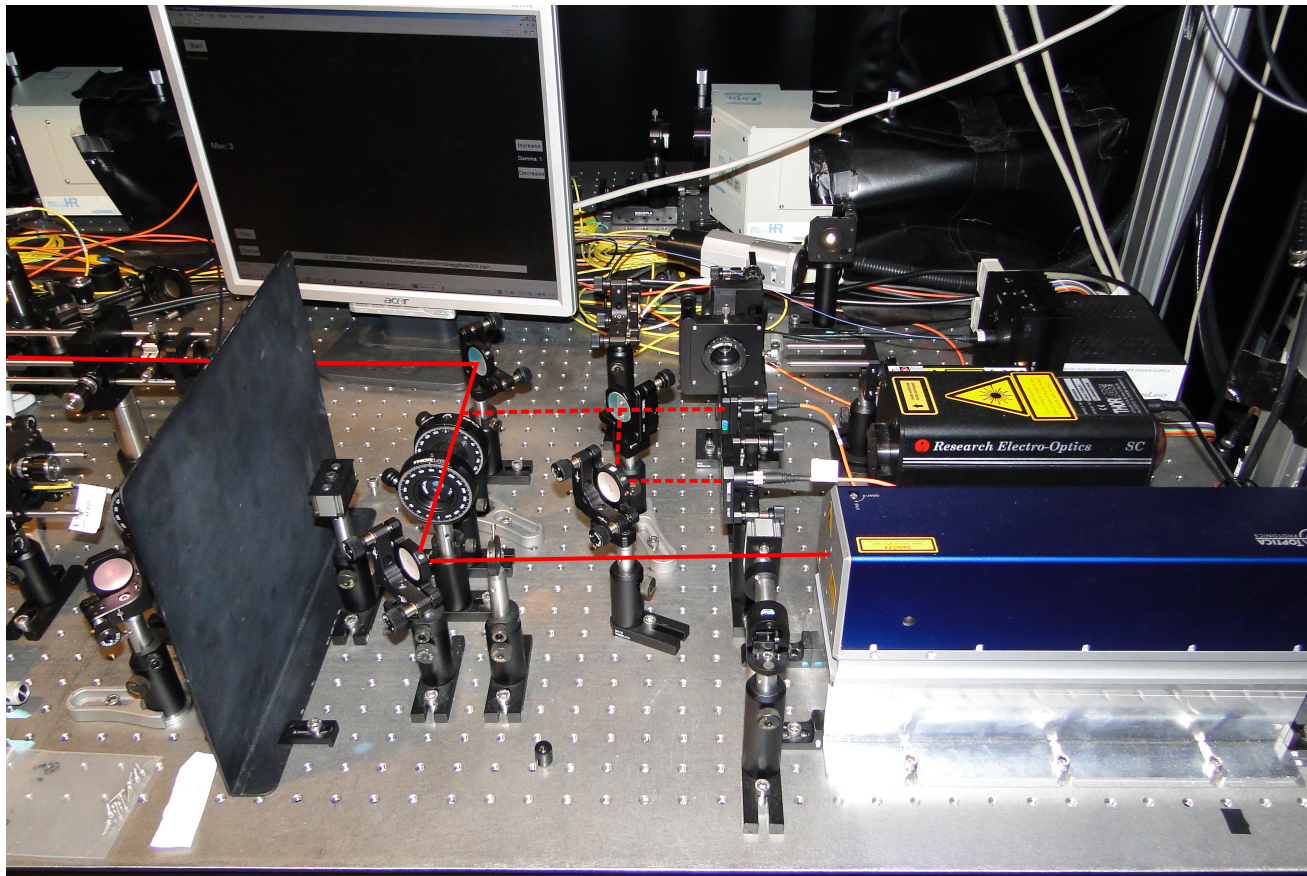

Setup – part 2

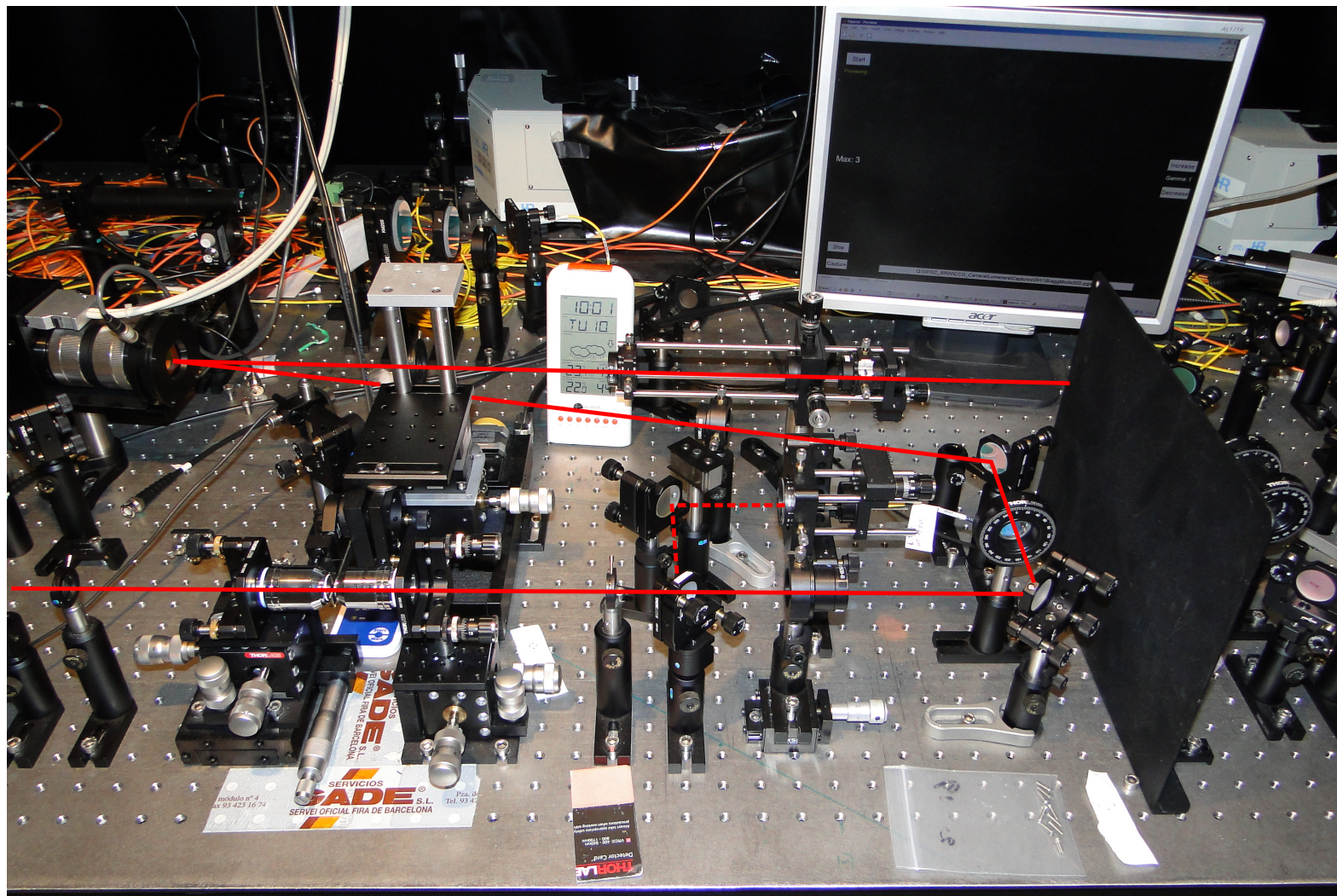

Setup – part 3

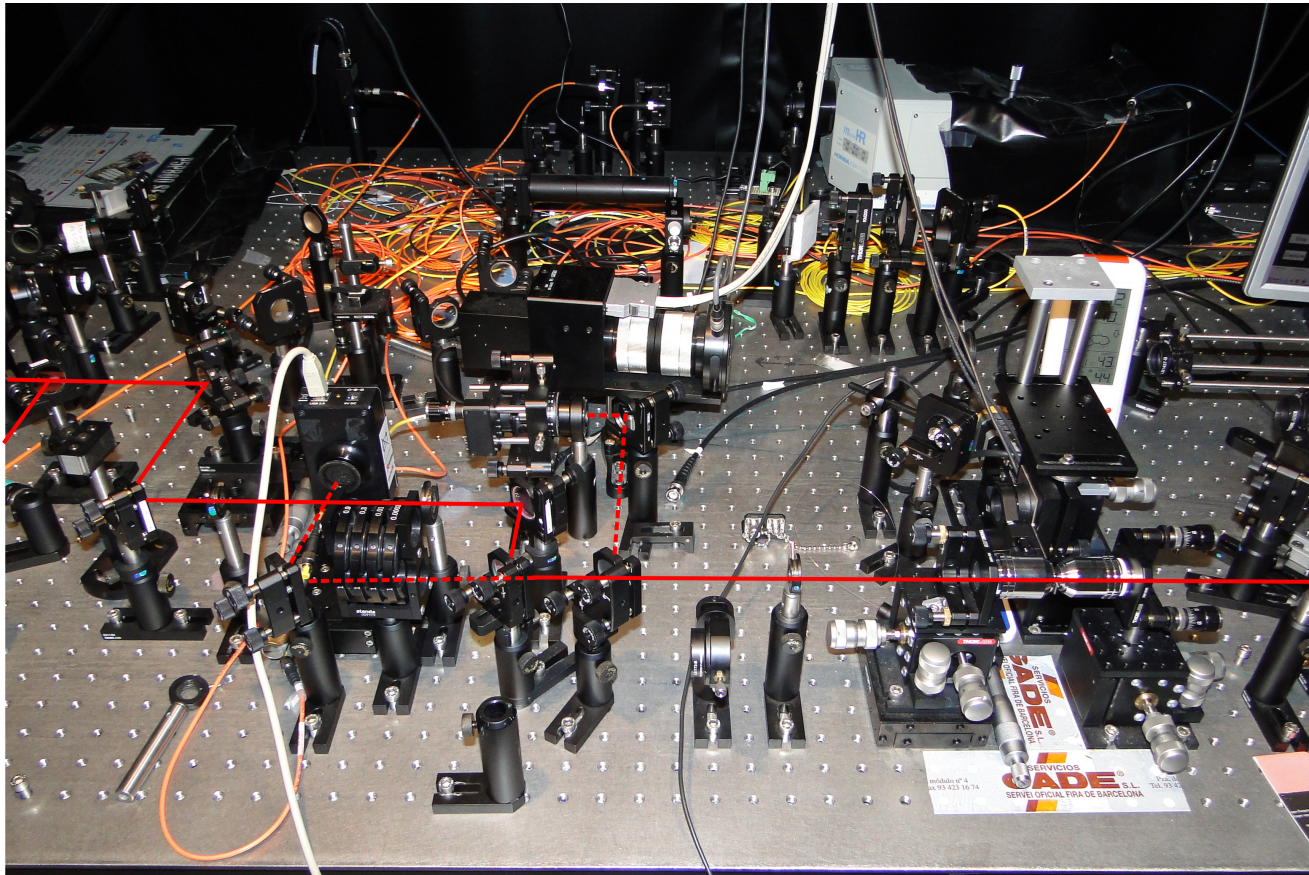

SHG generation with auxiliary laser

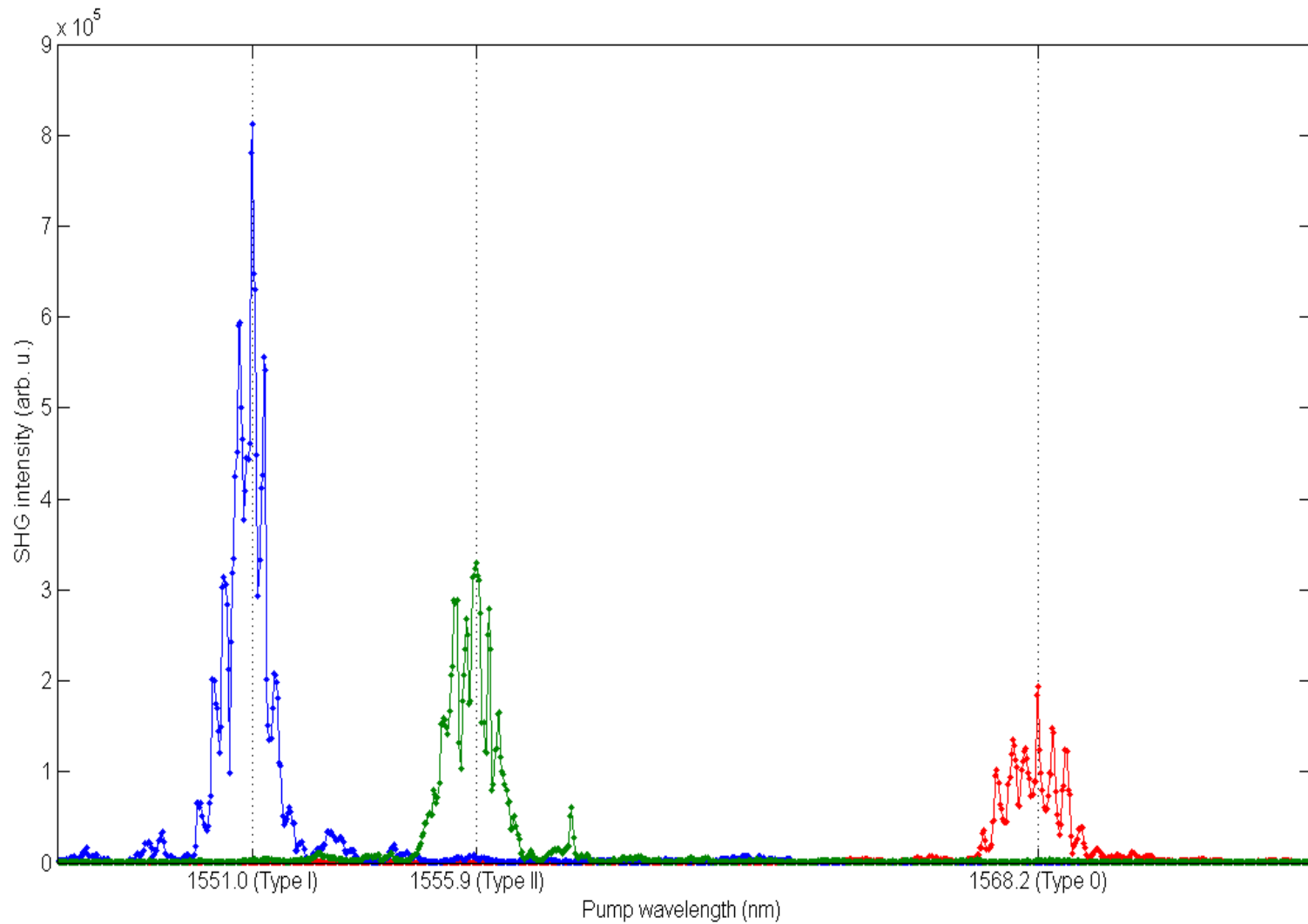

DLX 110

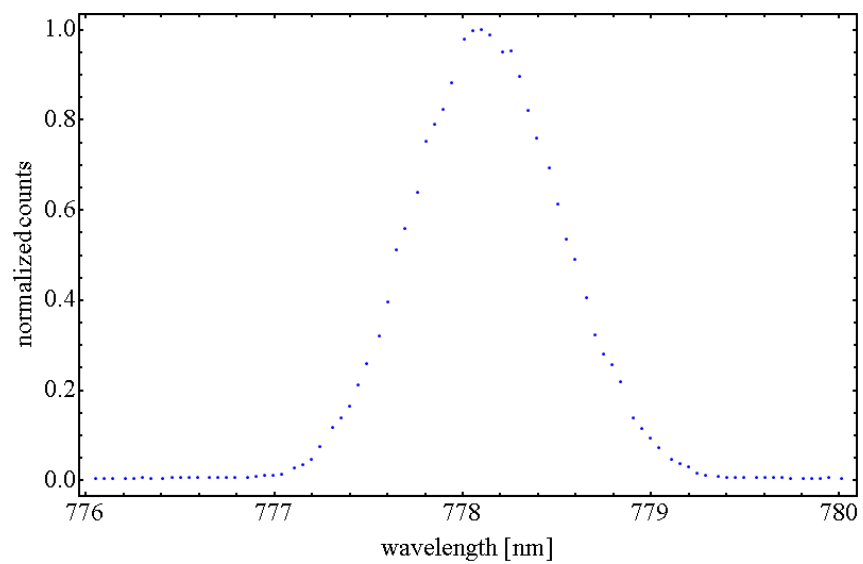

SHG

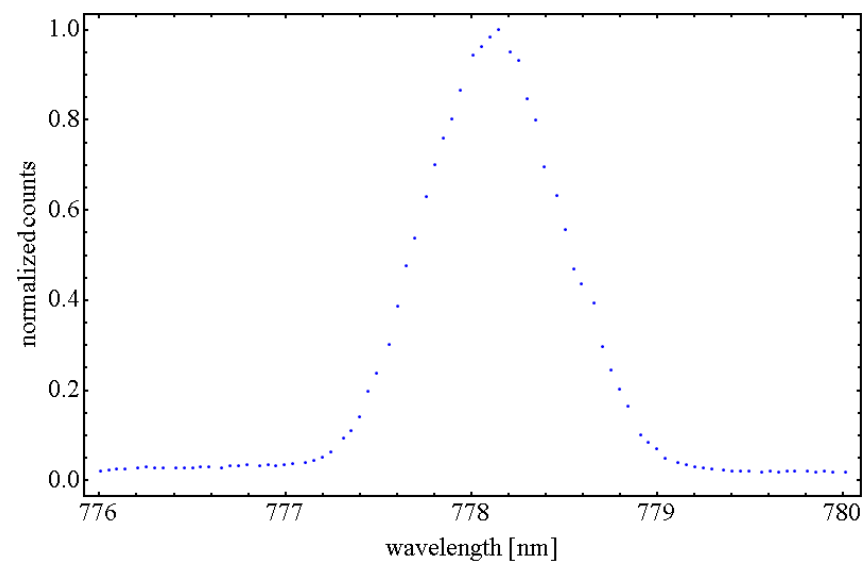

Setup – BRW detail

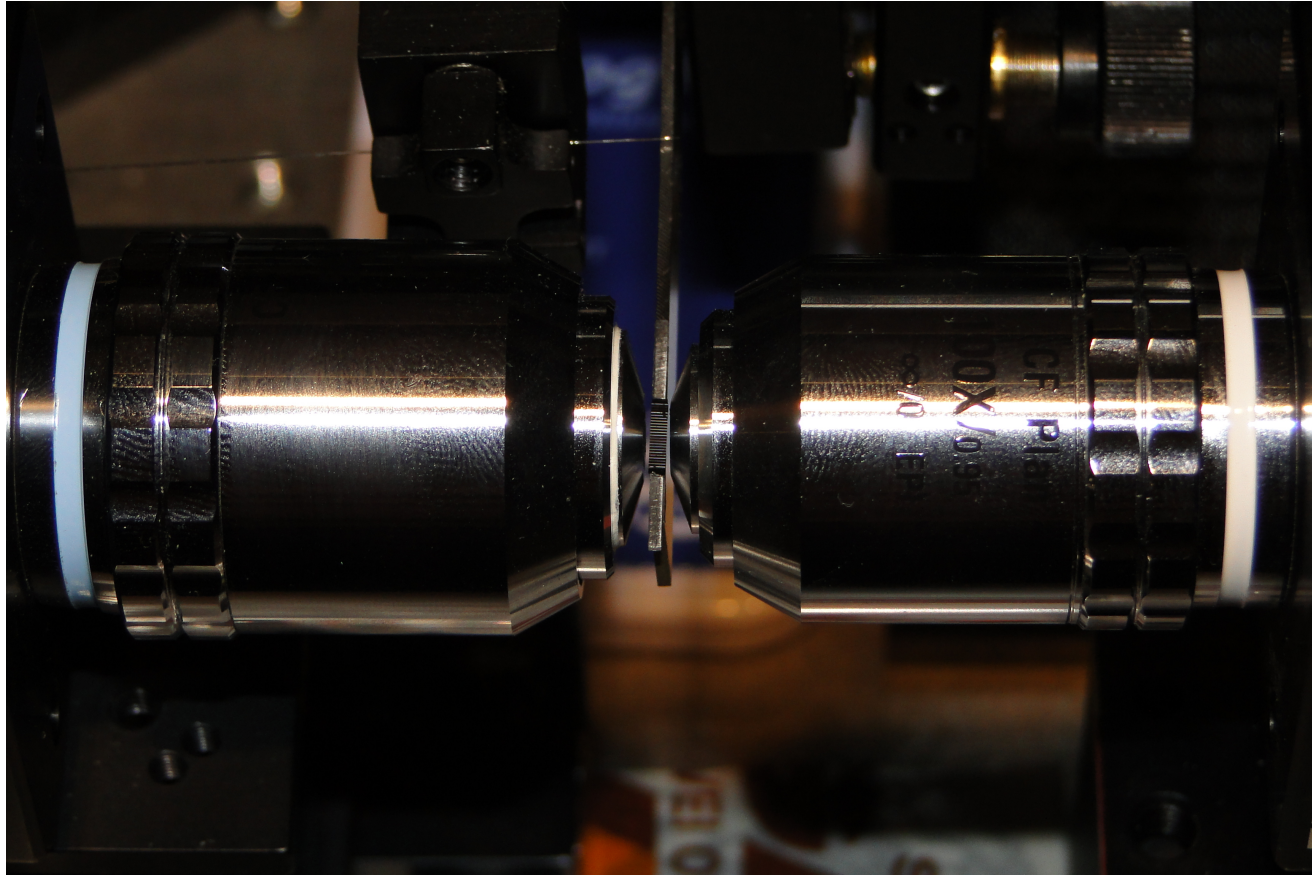

Begining of the sample

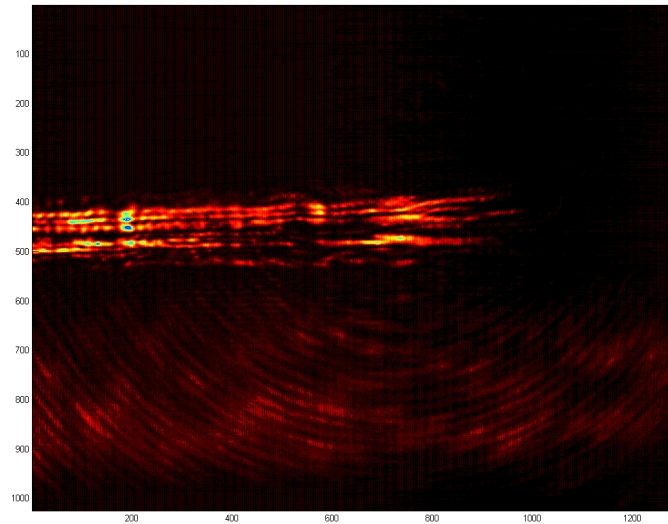

Etching part

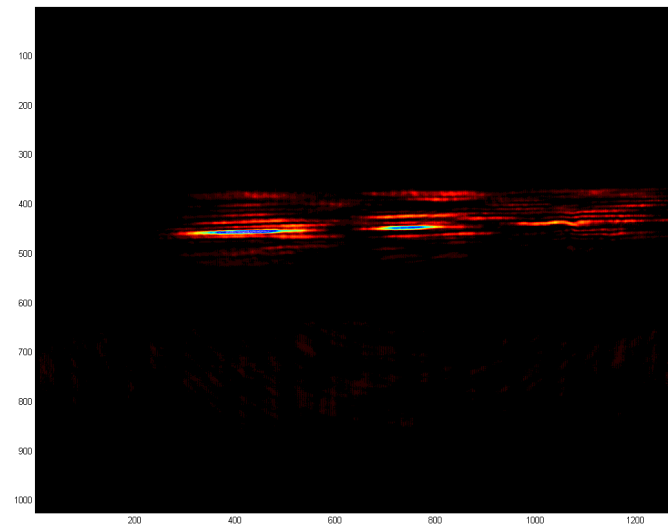

Beam in the BRW

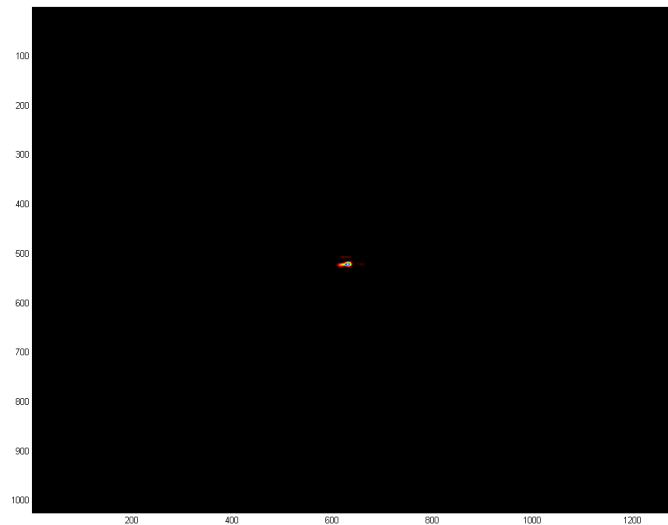

SHG on CCD camera

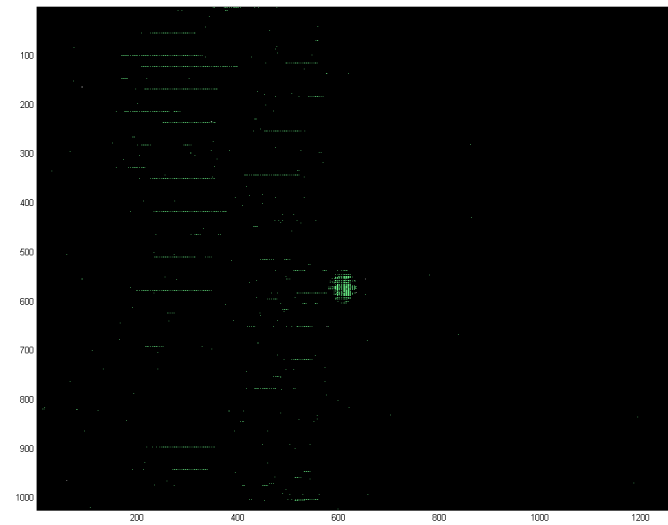

Setup – part 4

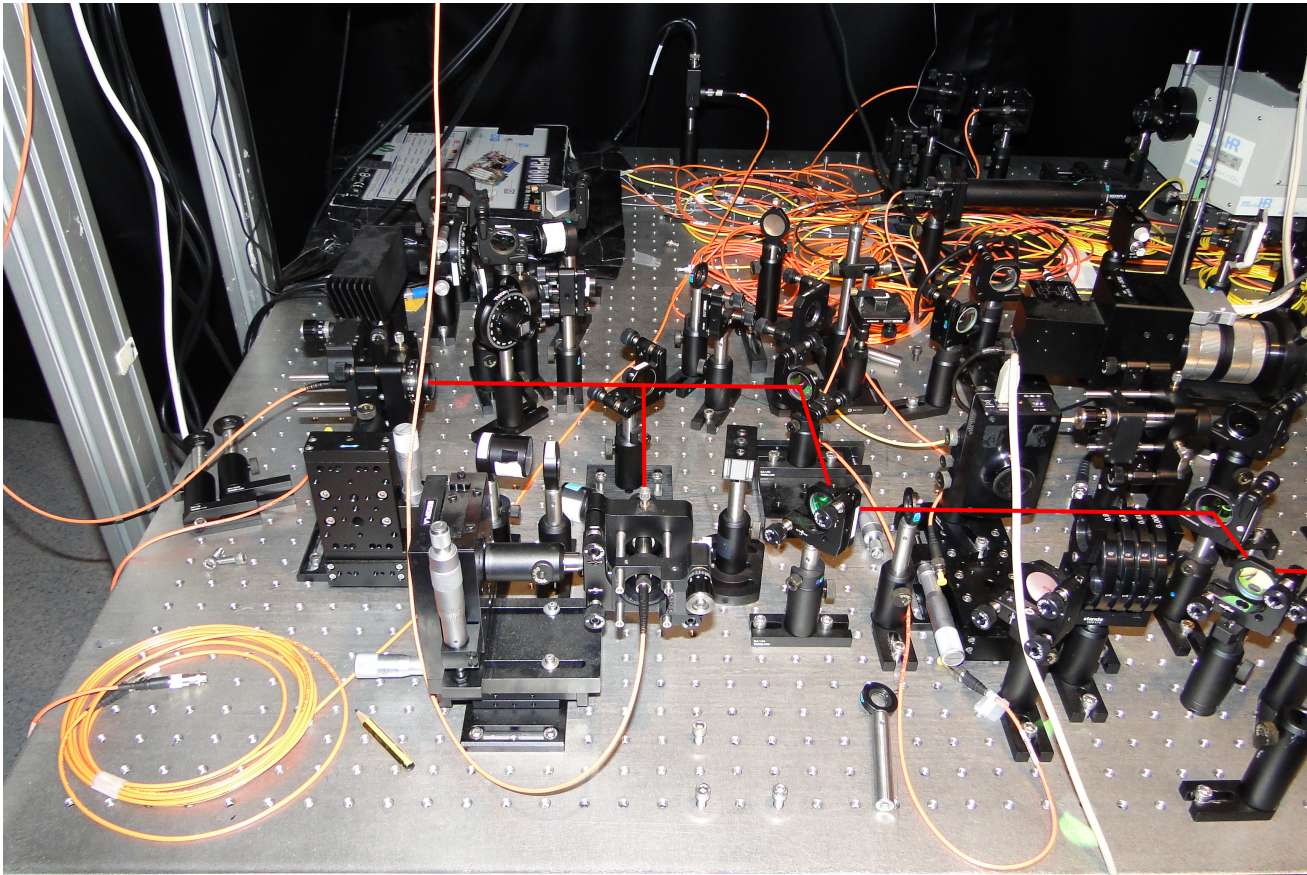

Thank you for your attention.